

CATALOG

SCREW

ANCHOR BOLT

PIPE HANGER



Mattech Pacific

Premium Engineering & Trading Solution

**PIPE HANGER SR-19
(ADJUSTABLE SPLITRING HANGER)
พวยแฉ่งเกอร์**

A-1

ชุดแขวนท่อ (พวยแฉ่งเกอร์), PIPE HANGER SR-19



Brand	"SRUB"
Material	Steel
Coating	With ZINC

Pipe Size		Rod size	H	Material size
mm	inch	inch	(mm)	(mm)
15	1/2"	3/8"	68	1.9x25
20	3/4"	3/8"	71	1.9x25
25	1"	3/8"	74	1.9x25
32	1 1/4"	3/8"	78	1.9x25
40	1 1/2"	3/8"	81	1.9x25
50	2"	3/8"	87	1.9x25
65	2 1/2"	3/8"	95	1.9x25
80	3"	3/8"	102	1.9x25
100	4"	3/8"	114	1.9x25
125	5"	1/2"	140	3.0x32
150	6"	1/2"	153	3.0x32
200	8"	5/8"	180	4.0x40



Mattech Pacific
Premium Engineering & Trading Solution

**PIPE HANGER SR-19
(ADJUSTABLE SPLITRING HANGER)
พวยแฉ่งเกอร์**

A-2

ชุดแขวนท่อ (พวยแฉ่งเกอร์), PIPE HANGER SR-19



Brand	"UROD"
Material	Steel
Coating	With ZINC

Pipe Size		Rod size	H	Material size
mm	inch	inch	(mm)	(mm)
15	1/2"	3/8"	68	1.5x25
20	3/4"	3/8"	71	1.5x25
25	1"	3/8"	74	1.5x25
32	1 1/4"	3/8"	78	1.5x25
40	1 1/2"	3/8"	81	1.5x25
50	2"	3/8"	87	1.5x25
65	2 1/2"	3/8"	95	1.5x25
80	3"	3/8"	102	1.5x25
100	4"	3/8"	114	1.5x25
125	5"	1/2"	140	2.5x25
150	6"	1/2"	153	2.5x25



Mattech Pacific
Premium Engineering & Trading Solution

**PIPE HANGER SR-19
(ADJUSTABLE SPLITRING HANGER)
พวยแสงเกอร์**

A-3

ชุดแขวนท่อ (พวยแสงเกอร์), SUS GRADE 304



Satandard	
Material	SUS (GRADE 304)
Coating	

Pipe Size		Rod size
mm	inch	inch
15	1/2"	3/8"
20	3/4"	3/8"
25	1"	3/8"
32	1 1/4"	3/8"
40	1 1/2"	3/8"
50	2"	3/8"
65	2 1/2"	3/8"
80	3"	3/8"
100	4"	3/8"
125	5"	1/2"
150	6"	1/2"



Mattech Pacific
Premium Engineering & Trading Solution

CLEVIS HANGER
(ADJUSTABLE CLEVIS HANGER)
เควิส แสงเกอร์

B-1

STANDARD CLEVIS HANGER



Satandard	
Material	Hot-Rolled steel
Coating	With Zinc,HDG

Pipe Size		Rod size	Hanger ID	H	B	C
mm	inch	inch	(mm)	(mm)	(mm)	(mm)
15	1/2"	3/8"	20	69.5	56	19.5
20	3/4"	3/8"	30	87.5	70	30
25	1"	3/8"	39	95.5	72.5	30.5
32	1 1/4"	3/8"	46	103	76	30.5
40	1 1/2"	3/8"	52	114	84.5	35
50	2"	3/8"	66	128	95	38.5
65	2 1/2"	1/2"	82	147	106	36
80	3"	1/2"	90	177.5	132.5	44
100	4"	1/2"	120	206.5	146.5	52.5
125	5"	5/8"	146	257	184	65.5
150	6"	5/8"	172	302	216	88
200	8"	5/8"	222	385	274	101.5
250	10"	7/8"	274	461	324	118.5
300	12"	7/8"	324	534	372	145
350	14"	7/8"	360	360	406	145



Mattech Pacific
 Premium Engineering & Trading Solution

**CLEVIS HANGER
(ADJUSTABLE CLEVIS HANGER)
เควีส แฮงเกอร์**

B-2

STANDARD CLEVIS HANGER, SUS GRADE 304



Satandard	
Material	SUS (GRADE 304)
Coating	

Pipe Size		Rod size	Hanger ID	H	B	C
mm	inch	inch	(mm)	(mm)	(mm)	(mm)
50	2"	3/8"	66	128	95	38.5
65	2 1/2"	1/2"	82	147	106	36
80	3"	1/2"	90	177.5	132.5	44
100	4"	1/2"	120	206.5	146.5	52.5
125	5"	5/8"	146	257	184	65.5
150	6"	5/8"	172	302	216	88
200	8"	5/8"	222	385	274	101.5
250	10"	7/8"	274	461	324	118.5
300	12"	7/8"	324	534	372	145
350	14"	7/8"	360	360	406	145



Mattech Pacific
Premium Engineering & Trading Solution

**STUD ROD
(THREADED ROD)
เหล็กเกลียวตลอด**

C-1

STUD ROD



Standard	THREADED ROD STANDARD
Material	
Coating	With ZINC

Rod Size		Length
mm	inch	mm
6	1/4"	1000
6	1/4"	1500
6	1/4"	2000
8	5/16"	1000
8	5/16"	1500
8	5/16"	2000
10	3/8"	1000
10	3/8"	1500
10	3/8"	2000
12	1/2"	1000
12	1/2"	1500
14	5/8"	1000
14	5/8"	1500
16	3/4"	1000
16	3/4"	1500
25	1"	1000
25	1"	1500

Remark: Maximum length up to 4 meter, available upon request



Mattech Pacific
Premium Engineering & Trading Solution

**STUD ROD
(THREADED ROD)
เหล็กเกลียวตลอด**

C-2

STUD ROD, SUS (GRADE 304)



Standard	THREADED ROD STANDARD
Material	SUS (GRADE 304)
Coating	

Rod Size		Length
mm	inch	mm
6	1/4"	1000
6	1/4"	1500
8	5/16"	1000
8	5/16"	1500
10	3/8"	1000
10	3/8"	1500
12	1/2"	1000
12	1/2"	1500
14	5/8"	1000
14	5/8"	1500
16	3/4"	1000

Remark: Maximum length up to 4 meter, available upon request



Mattech Pacific
Premium Engineering & Trading Solution

U-BOLT

ยูโบลว์ เข็มขัดรัดท่อ

D-1

LIGHT DUTY U-BOLT



Satandard	
Material	
Coating	With zinc

Pipe Size		Rod Size	
mm	inch	mm	inch
15	1/2"	6	1/4"
20	3/4"	6	1/4"
25	1"	8	5/16"
32	1 1/4"	8	5/16"
40	1 1/2"	8	5/16"
50	2"	8	5/16"
65	2 1/2"	10	5/16"
80	3"	10	3/8"
100	4"	10	3/8"
125	5"	10	3/8"
150	6"	10	3/8"
200	8"	10	3/8"

Remark: Speacial size available upon request



Mattech Pacific
Premium Engineering & Trading Solution

U-BOLT

ยูโบลว เชื่อมขันรัดท่อ

D-2

STAINLESS U-BOLT, SUS (GRADE 304)



Satandard	
Material	SUS (GRADE 304)
Coating	

Pipe Size		Rod Size	
mm	inch	mm	inch
15	1/2"	6	1/4"
20	3/4"	6	1/4"
25	1"	8	5/16"
32	1 1/4"	8	5/16"
40	1 1/2"	8	5/16"
50	2"	8	5/16"
65	2 1/2"	10	5/16"
80	3"	10	3/8"
100	4"	10	3/8"
125	5"	10	3/8"
150	6"	10	3/8"
200	8"	10	3/8"

Remark: Speacial size available upon request



Mattech Pacific
Premium Engineering & Trading Solution

U-BOLT

ยูโบลท์ เข็มขัดรัดท่อ

D-3

STANDARD U-BOLT



Satandard	
Material	
Coating	With ZINC

Pipe Size		Rod Size	
mm	inch	mm	inch
15	1/2"	6	3/8"
20	3/4"	6	3/8"
25	1"	8	3/8"
32	1 1/4"	8	3/8"
40	1 1/2"	8	3/8"
50	2"	8	3/8"
65	2 1/2"	10	3/8"
80	3"	10	1/2"
100	4"	10	1/2"
125	5"	10	1/2"
150	6"	10	1/2"
200	8"	10	5/8"
250	10"	10	5/8"
300	12"	10	3/4"
350	14"	10	3/4"

Remark: Speacial size available upon request



Mattech Pacific
Premium Engineering & Trading Solution

STRAP U-BOLT

ยูแบน

E-1

STRAP U-BOLT



Satandard	
Material	
Coating	With ZINC

Pipe Size		Steel size	Rod size
mm	inch	mm	inch
50	2"	3x25	3/8"
65	2 1/2"	3x25	3/8"
80	3"	3x32	3/8"
100	4"	4x32	1/2"
125	5"	4x32	1/2"
150	6"	5x38	5/8"
200	8"	5x38	5/8"
250	10"	5x50	3/4"
300	12"	5x50	7/8"

Remark: Speacial size available upon request



Mattech Pacific
Premium Engineering & Treeding Solution

STRAP U-BOLT

ยูแบน

E-2

STAINLESS STRAP U-BOLT, SUS (GRADE 304)



Standard	
Material	SUS (GRADE 304)
Coating	

Pipe Size		Steel size	Rod size
mm	inch	mm	inch
50	2"	3x25	3/8"
65	2 1/2"	3x25	3/8"
80	3"	3x32	3/8"
100	4"	4x32	1/2"
125	5"	4x32	1/2"
150	6"	5x38	5/8"
200	8"	5x38	5/8"
250	10"	5x50	3/4"
300	12"	5x50	7/8"

Remark: Special size available upon request



Mattech Pacific
Premium Engineering & Trading Solution

LEVEL PIPE CLAMP

แคลมรัดท่อปรับระดับ

F-1

LEVEL PIPE CLAMP

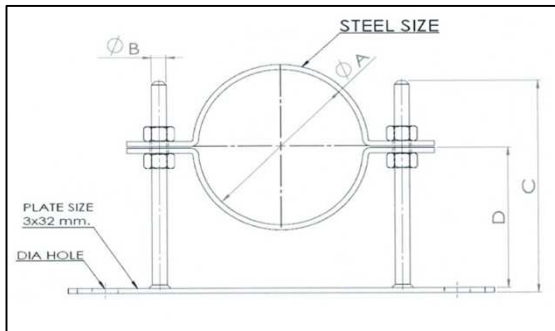

Satandard	
Material	
Coating	With ZINC

Pipe Size		Steel size	B	C	Hole
mm	inch	mm	inch	mm	(mm)
25	1"	2x25	3/8"	120L	10
40	1 1/2"	2x25	3/8"		10
50	2"	2.5x25	3/8"		10
65	2 1/2"	2.5x25	3/8"		10
80	3"	2.5x25	3/8"		10
100	4"	2.5x25	3/8"		14
25	1"	2x25	3/8"	150L	10
40	1 1/2"	2x25	3/8"		10
50	2"	2.5x25	3/8"		10
65	2 1/2"	2.5x25	3/8"		10
80	3"	2.5x25	3/8"		10
100	4"	2.5x25	3/8"		14

Remark: Special size available upon request



Mattech Pacific
Premium Engineering & Trading Solution

BAND HANGER

หยดน้ำ

G-1

BAND HANGER



Satandard	
Material	
Coating	With ZINC

Pipe Size		Rod Size	
mm	inch	mm	inch
15	1/2"	10	3/8"
20	3/4"	10	3/8"
25	1"	10	3/8"
32	1 1/4"	10	3/8"
40	1 1/2"	10	3/8"
50	2"	10	3/8"
65	2 1/2"	10	3/8"
80	3"	10	3/8"
100	4"	10	3/8"
125	5"	15	1/2"
150	6"	15	1/2"
200	8"	15	1/2"

Remark: Speacial size available upon request



Mattech Pacific
Premium Engineering & Trading Solution

BAND HANGER

หยดน้ำ

G-2

BAND HANGER, SUS (GRADE 304)



Satandard	
Material	SUS (GRADE 304)
Coating	

Pipe Size		Rod Size	
mm	inch	mm	inch
15	1/2"	10	3/8"
20	3/4"	10	3/8"
25	1"	10	3/8"
32	1 1/4"	10	3/8"
40	1 1/2"	10	3/8"
50	2"	10	3/8"
65	2 1/2"	10	3/8"
80	3"	10	3/8"
100	4"	10	3/8"
125	5"	15	1/2"
150	6"	15	1/2"
200	8"	15	1/2"

Remark: Special size available upon request



Mattech Pacific
Premium Engineering & Trading Solution

ADJUSTABLE FOOT

ฝาจิ้ง ขาจิ้ง

H-1

ADJUSTABLE FOOT



Satandard	
Material	
Coating	With ZINC

Foot pad size	Rod size
inch	inch
2"x3/8"	2"x3/8"
3"x3/8"	3"x3/8"
3"x1/2"	3"x1/2"
3"x5/8"	3"x5/8"
4"x3/8"	3"xM12
4"x1/2"	3"xM16
4"x5/8"	
Install anchor bolt type	
3"x3/8"	3"x3/8"
3"x1/2"	3"x1/2"
3"x5/8"	3"x5/8"
	3"xM12
	3"xM16



Mattech Pacific
Premium Engineering & Treeding Solution

ADJUSTABLE FOOT

ฝาจิ้ง ขาจิ้ง

H-2

STAINLESS ADJUSTABLE FOOT



Satandard	
Material	STAINLESS
Coating	

Foot pad size	Rod size
inch	inch
2"x3/8"	2"x3/8"
3"x3/8"	3"x3/8"
3"x1/2"	3"x1/2"
3"x5/8"	3"x5/8"
4"x3/8"	3"xM12
4"x1/2"	3"xM16
4"x5/8"	
Install anchor bolt type	
3"x3/8"	3"x3/8"
3"x1/2"	3"x1/2"
3"x5/8"	3"x5/8"
	3"xM12
	3"xM16



Mattech Pacific
Premium Engineering & Treading Solution

U-CLAMP

ยูแคลมป์

I-1

U-CLAMP

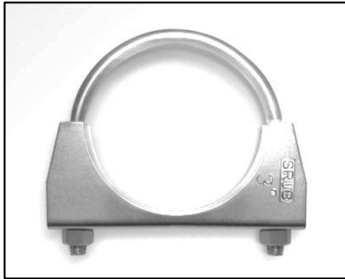

Satandard	
Material	
Coating	With ZINC

Pipe Size		Steel size	Rod size
mm	inch	mm	inch
25	1"	1 1/4"	5/16"
32	1 1/4"	1 1/2"	5/16"
-	1 3/4"	1 3/4"	5/16"
40	1 1/2"	2"	5/16"
50	2"	2 1/2"	5/16"
65	2 1/2"	3"	5/16"



Mattech Pacific
Premium Engineering & Trading Solution

BEAM CLAMP

แคล้มพีนจระเข้

J-1

BEAM CLAMP

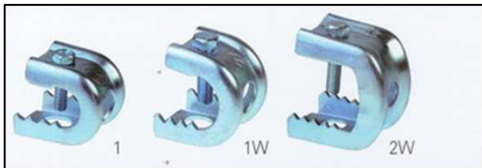

Satandard	
Material	
Coating	With ZINC

TYPE	Beam size
	mm.
1	14 mm.
1W	20 mm.
2W	30 mm.

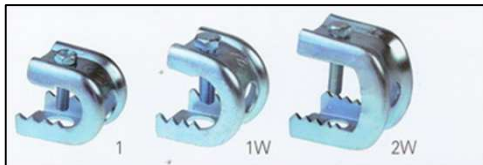

Satandard	
Material	STAINLESS
Coating	

TYPE	Beam size
	mm.
1	14 mm.
1W	20 mm.
2W	30 mm.



Mattech Pacific
Premium Engineering & Trading Solution

APPLICABLE HANGER

แคล้มวงเดือน

K-1

APPLICABLE HANGER

Satandard	
Material	
Coating	With ZINC



Size	
mm.	Inch
15	1/2"
20	3/4"
25	1"
32	1 1/4"
40	1 1/2"
50	2"

Satandard	
Material	STAINLESS
Coating	



Size	
mm.	Inch
15	1/2"
20	3/4"
25	1"
32	1 1/4"
40	1 1/2"
50	2"



Mattech Pacific
Premium Engineering & Trading Solution

OHM CLAMP/E.M.T./I.M.C./STAINLESS

แคล้มโอล์มเหล็กบาง/หนา/สแตนเลส

L-1

OHM CLAMP



Satandard	
Material	SUS
Coating	With ZINC

Size (E.M.T.)		Size (I.M.C.)		Size (SUS)	
mm.	Inch	mm.	Inch	mm.	Inch
15	1/2"	15	1/2"	15	1/2"
20	3/4"	20	3/4"	20	3/4"
25	1"	25	1"	25	1"
32	1 1/4"	32	1 1/4"	32	1 1/4"
40	1 1/2"	40	1 1/2"	40	1 1/2"
50	2"	50	2"	50	2"
		65	2 1/2"	65	2 1/2"
		80	3"	80	3"
		90	3 1/2"	90	3 1/2"
		100	4"	100	4"



Mattech Pacific
Premium Engineering & Trading Solution

ANCHOR BOLT

พุก

M-1

ANCHOR BOLT



ANCHOR BOLT (Hot dip Galvanized)		
SIZE"		PCS/Box
(mm.)	(Inch)	
	ST 1/4"	200
	ST 5/16"	100
M10	ST 3/8"	75
	ST 1/2"	30
	ST 5/8"	20



DROP-IN (Hot dip Galvanized)		
SIZE"		PCS/Box
(mm.)	(Inch)	
	DR 1/4"	100
	DR 5/16"	100
M10	DR 3/8"	50
	DR 1/2"	50
	DR 5/8"	25
	DR 3/4"	20



DOUBLE (Hot dip Galvanized)		
SIZE"		PCS/Box
(mm.)	(Inch)	
	DR 1/4"	100
	DR 5/16"	100
M10	DR 3/8"	50
	DR 1/2"	50
	DR 5/8"	25



Mattech Pacific
Premium Engineering & Trading Solution

ANCHOR BOLT

พุก

M-2

ANCHOR BOLT (STAINLESS GRADE 304)



ANCHOR BOLT (Hot dip Galvanized)		
SIZE"		PCS/Box
(mm.)	(Inch)	
M6	ST 1/4"	200
M8	ST 5/16"	100
M10	ST 3/8"	75
M12	ST 1/2"	30
M16	ST 5/8"	20



DROP-IN (Hot dip Galvanized)		
SIZE"		PCS/Box
(mm.)	(Inch)	
M6	DR 1/4"	100
M8	DR 5/16"	100
M10	DR 3/8"	50
M12	DR 1/2"	50
M16	DR 5/8"	25
M20	DR 3/4"	20



ROD COUPLING	
Hot dip Galvanized	
SIZE"	
3/8" x 40mm.	
1/2" x 40mm.	
5/8 x 40mm.	
3/4" x 40 mm.	



Mattech Pacific
Premium Engineering & Trading Solution

C-CHANNEL CLAMP

แคล้มประกับ,รางซี

N-1

C-CHANNEL CLAMP, C-CHANNEL



Size (E.M.T.)		Size (I.M.C.)	
mm.	Inch	mm.	Inch
15	1/2"	15	1/2"
20	3/4"	20	3/4"
25	1"	25	1"
32	1 1/4"	32	1 1/4"
40	1 1/2"	40	1 1/2"
50	2"	50	2"
65	2 1/2"	65	2 1/2"
80	3"	80	3"



C-Channel	
Type	Size.(mm.)
Normal	20x40x1200



Mattech Pacific
Premium Engineering & Trading Solution

BOLT, WASHER, NUT

น๊อต,แหวน,หัวน๊อตชุบ

0-1

BOLT, WASHER, NUT (ZINC)

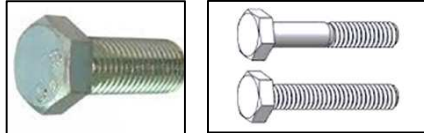

Size "Inch"	1/4"	5/16"	3/8"	7/16"	1/2"	5/8"	3/4"
Threaded Length	20 mm.	18 mm.	16 mm.	14 mm.	12 mm.	11 mm.	10 mm.
1/2"	●	●					
5/8"	●	●					
3/4"	●	●	●				
1"	●	●	●	●	●	●	●
1 1/4"	●	●	●	●	●	●	●
1 1/2"	●	●	●	●	●	●	●
1 3/4"	●	●	●	●	●	●	●
2"	●	●	●	●	●	●	●
2 1/2"	●	●	●	●	●	●	●
3"	●	●	●	●	●	●	●
3 1/2"	●	●	●	●	●	●	●
4"	●	●	●	●	●	●	●
4 1/2"	●	●	●	●	●	●	●
5"			●	●	●	●	●
5 1/2"			●	●	●	●	●
6"			●	●	●	●	●



Size "Inch"	1/4"	5/16"	3/8"	7/16"	1/2"	5/8"	3/4"
Threaded	20 mm.	18 mm.	16 mm.	14 mm.	12 mm.	11 mm.	10 mm.



Size "mm"	M6	M8	M10	M12	M14	M18	M20
-----------	----	----	-----	-----	-----	-----	-----

Note: We are supplier every type & size of screw, contact please



Mattech Pacific
Premium Engineering & Trading Solution

BOLT, WASHER, NUT

น๊อต,แหวน,หัวน๊อตสแตนเลส

0-2

BOLT, WASHER, NUT (SUS GRADE 304)

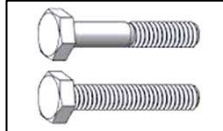
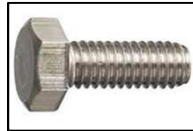

Size "Inch"	1/4"	5/16"	3/8"	1/2"	5/8"	3/4"	7/8"
Length							
1/2"	●	●	-	-	-	-	-
5/8"	●	●	-	-	-	-	-
3/4"	●	●	●	-	-	-	-
1"	●	●	●	●	●	-	-
1 1/4"	●	●	●	●	●	-	-
1 1/2"	●	●	●	●	●	●	-
2"	●	●	●	●	●	●	-
2 1/2"	●	●	●	●	●	●	●
3"	●	●	●	●	●	●	●
3 1/2"	●	●	●	●	●	●	●
4"	●	●	●	●	●	●	●
4 1/2"	-	●	●	●	●	●	●
5"	-	●	●	●	●	●	●
5 1/2"	-	●	●	●	●	●	●
6"	-	●	●	●	●	●	●
7"	-	-	●	●	●	●	●
8"	-	-	●	●	●	●	●
9"	-	-	●	●	●	●	●
10"	-	-	●	●	●	●	●
11"	-	-	●	●	●	●	●
12"	-	-	●	●	●	●	●



SZIE (INCH)							
1/4"	5/16"	3/8"	1/2"	5/8"	3/4"	7/8"	



1/4"	5/16"	3/8"	1/2"	5/8"	3/4"	7/8"	
------	-------	------	------	------	------	------	--



1/4"	5/16"	3/8"	1/2"	5/8"	3/4"	7/8"	
------	-------	------	------	------	------	------	--



Mattech Pacific
Premium Engineering & Trading Solution

BOLT, WASHER, NUT (UNC, UNF)

UNC:เกลียวหยาบ, UNF:เกลียวละเอียด
 น็อต,แหวน,หัวน็อตเหล็กแข็ง

0-3

BOLT, WASHER, NUT (UNC, UNF)



Size "Inch"	1/4"	5/16"	3/8"	7/16"	1/2"	9/16"
Threaded 1" (UNC)	20	18	16	14	13	12
Threaded 1" (UNF)	28	24	24	20	20	18
Head size (mm.)	7/16"(11.12)	1/2"(12.70)	9/16"(14.27)	5/8"(15.87)	3/4"(19.05)	13/16"(20.6)
Head thick. (mm.)	5/32"(3.97)	13/64"(5.16)	15/64"(5.94)	9/32"(7.14)	5/16"(7.94)	23/64"(9.13)
Length						
1/2"	●		-	-	-	-
3/4"	●	●	●	●	●	-
1"	●	●	●	●	●	●
1 1/4"	●	●	●	●	●	●
1 1/2"	●	●	●	●	●	●
1 3/4"	●	●	●	●	●	●
2"	●	●	●	●	●	●
2 1/2"	●	●	●	●	●	●
3"	●	●	●	●	●	●
3 1/2"	●	●	●	●	●	●
4"	●	●	●	●	●	●
4 1/2"	●	●	●	●	●	●
5"	●	●	●	●	●	●
5 1/2"		●	●	●	●	●
6"	●	●	●	●	●	●

— Above this line are whole threaded



Mattech Pacific
 Premium Engineering & Trading Solution

BOLT, WASHER, NUT (UNC, UNF)
 UNC:เกลียวหยาบ, UNF:เกลียวละเอียด
 น็อต,แหวน,หัวน็อตเหล็กแข็ง(ใหญ่)

O-4

BOLT,WASHER,NUT (UNC,UNF) BIG



Size "Inch"	1/2"	5/8"	3/4"	7/8"	1"
Threaded 1" (UNC)	13	11	10	9	8
Threaded 1" (UNF)	20	18	16	14	12
Head size (mm.)	3/4"	15/16"	1 1/8"	15/16"	1 1/2"
Head thick. (mm.)	5/16"	25/64"	15/32"	35/64"	39/64"
Length					
1 1/2"	-	●	●	-	-
1 3/4"	-	●	●	●	●
2"	-	●	●	●	●
2 1/2"	-	●	●	●	●
3"	-	●	●	●	●
3 1/2"	-	●	●	●	●
4"	-	●	●	●	●
4 1/2"	-	●	●	●	●
5"	-	●	●	●	●
5 1/2"	-	●	●	●	●
6"	-	●	●	●	●
6 1/2"	●	●	●	●	●
7"	●	●	●	●	●
8"	●	●	●	●	●
9"	●	●	●	●	●
10"	●	●	●	●	●
11"	●	●	●	●	●
12"	●	●	●	●	●
13"	-	●	●	●	●
14"	-	●	●	●	●
15"	-	-	●	-	●

— Above this line are whole threaded



Mattech Pacific
 Premium Engineering & Trading Solution

TAPPING SCREW F,P

สกรูเกลียวปล่อย

0-5

TAPPING SCREW

F



P



Diameter/Length						
#4	#6	#7	#8	#10	#12	#14
1/4"	1/4"	-	-	-	-	-
3/8"	3/8"	3/8"	3/8"	3/8"	-	-
1/2"	1/2"	1/2"	1/2"	1/2"	1/2"	1/2"
5/8"	5/8"	5/8"	5/8"	5/8"	5/8"	5/8"
3/4"	3/4"	3/4"	3/4"	3/4"	3/4"	3/4"
1"	1"	1"	1"	1"	1"	1"
1 1/4"	1 1/4"	1 1/4"	1 1/4"	1 1/4"	1 1/4"	1 1/4"
1 1/2"	1 1/2"	1 1/2"	1 1/2"	1 1/2"	1 1/2"	1 1/2"
	2"	2"	2"	2"	2"	2"
			2 1/2"	2 1/2"	2 1/2"	2 1/2"
			3"	3"	3"	3"



Mattech Pacific
Premium Engineering & Trading Solution

TAPPING SCREW F,P (SUS GRADE 304)

O-6

สกรูเกลียวปหล่อยสแตนเลส

SCREW (SUS GRADE 304)

F



P



Diameter/Length						
#4	#6	#7	#8	#10	#12	#14
1/4"		-	-	-	-	-
3/8"	3/8"	3/8"	3/8"	3/8"	-	-
1/2"	1/2"	1/2"	1/2"	1/2"	1/2"	1/2"
5/8"	5/8"	5/8"	5/8"	5/8"	5/8"	5/8"
3/4"	3/4"	3/4"	3/4"	3/4"	3/4"	3/4"
1"	1"	1"	1"	1"	1"	1"
1 1/4"	1 1/4"	1 1/4"	1 1/4"	1 1/4"	1 1/4"	1 1/4"
					7/8"	
1 1/2"	1 1/2"	1 1/2"	1 1/2"	1 1/2"	1 1/2"	1 1/2"
	2"	2"	2"	2"	2"	2"
	2 1/2"	2 1/2"	2 1/2"	2 1/2"	2 1/2"	2 1/2"
	3"	3"	3"	3"	3"	3"
			3 1/2"	3 1/2"	3 1/2"	3 1/2"
			4"	4"	4"	4"
					5"	
					6"	



Mattech Pacific
Premium Engineering & Trading Solution

FLAT HEAD SELF TAPPING SCREW

สกรูปลายสว่านหัวเตเปอร์

0-7

FLAT HEAD SELT TAPPING SCREW



Size	#8
Length	1/2"
	5/8"
	3/4"
	1"
	1 1/4"
	1 1/2"
	2"
	2 1/2"
3"	



Flat head wingtek

Size	Length
#7	3/4"
	1"
	1 1/4"
	1 1/2"
	2"
#8	3/4"
	1"
	1 1/4"
	1 1/2"
	2"



Turnbuckle

Size
3/16"
1/4"
5/16"
3/8"
1/2"
5/8"
3/4"
7/8"
1"



Mattech Pacific
Premium Engineering & Trading Solution



CONTACT

Mattech Pacific

Premium Engineering & Trading Solution

บริษัท แมทเทค แปซิฟิก จำกัด
123 หมู่ 2 ด.หนองไม้แดง ถ.วิบูลย์ธรรมรักษ์
อ.เมือง จ.ชลบุรี 20000
โทร: +66(0)38-780763
+66(0)38-781080
แฟกซ์: +66(0)38-780071
+66(0)38-140262

MATTECH PACIFIC CO.,LTD
123 M.2 , Nongmaidang, Wiboontamarak Rd,
Mueang, Chonburi, 20000
Tel: +66(0)38-780763
+66(0)38-781080
Fax: +66(0)38-780071
+66(0)38-140262

E-mail : Sales@mattechpacific.com

